

Breton Top

Project design © Love Productions 2016
This design is protected by copyright and
must not be made for resale.

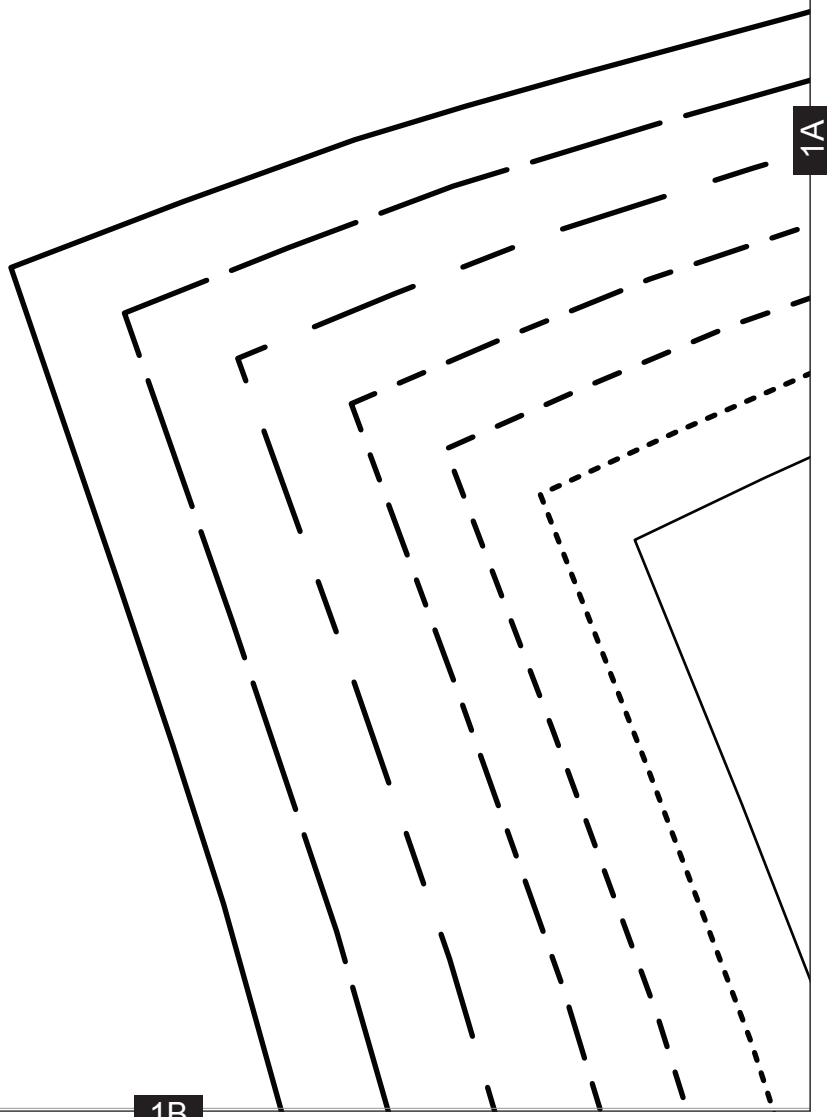

1A

1B

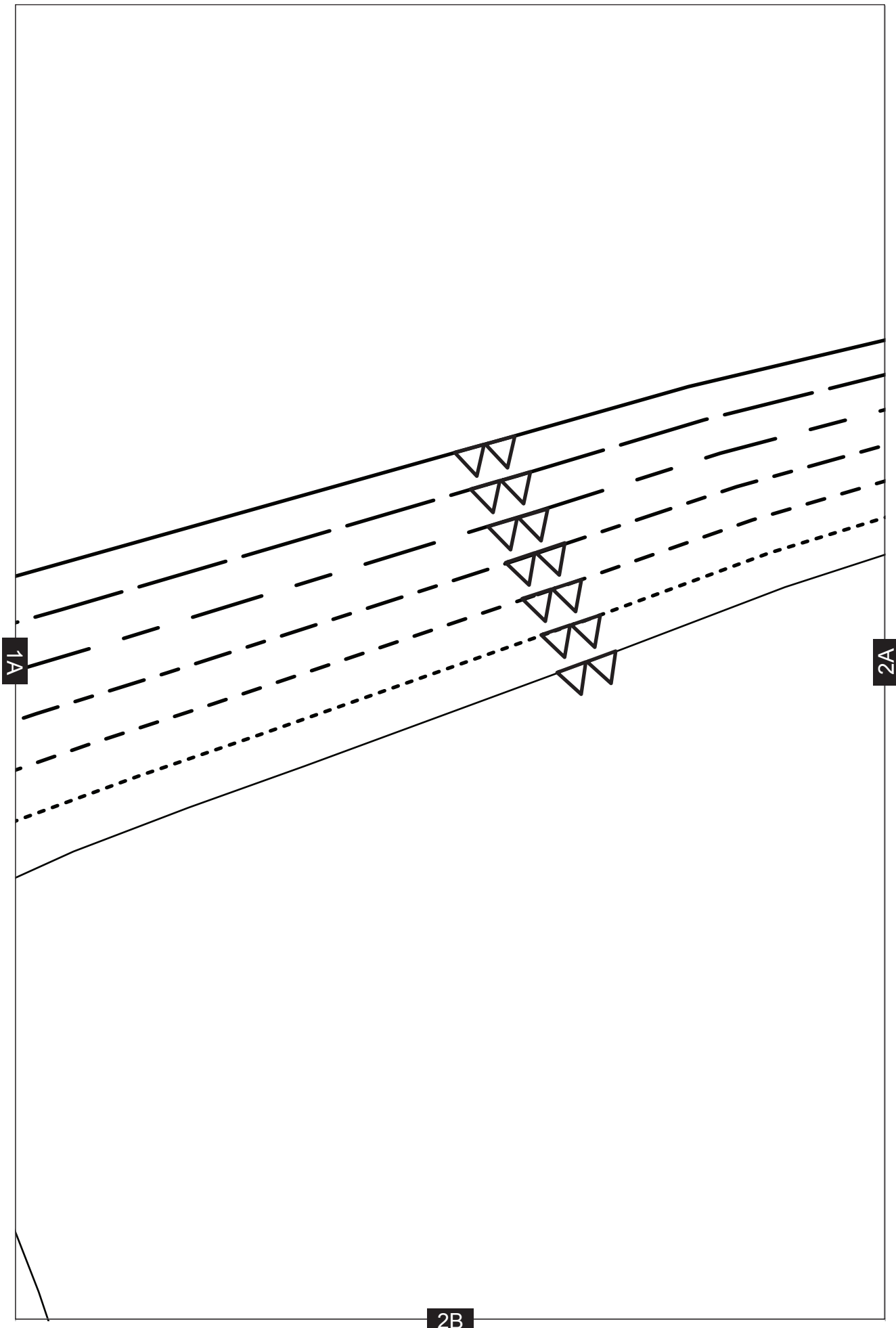

1A

2A

2B

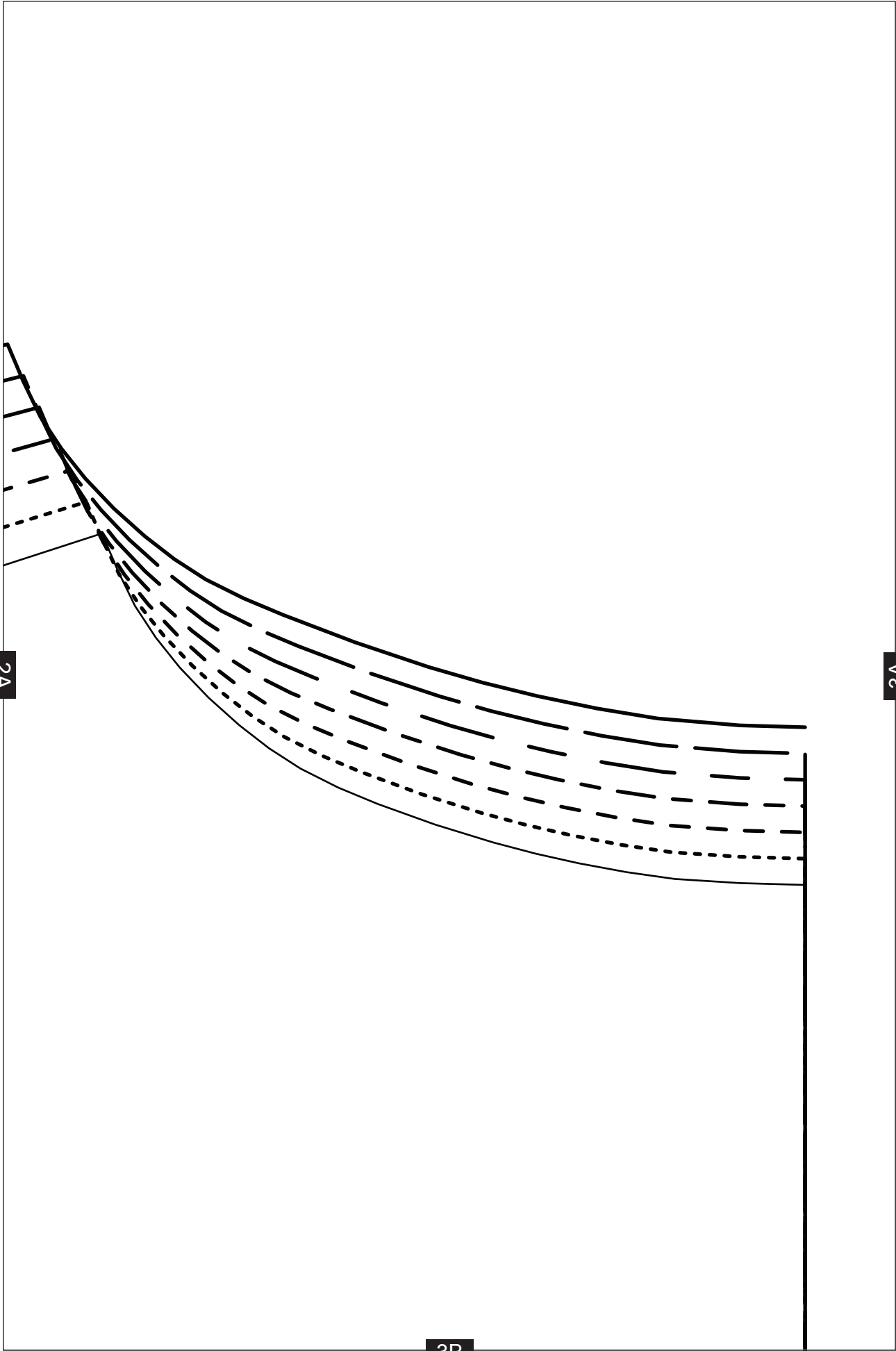

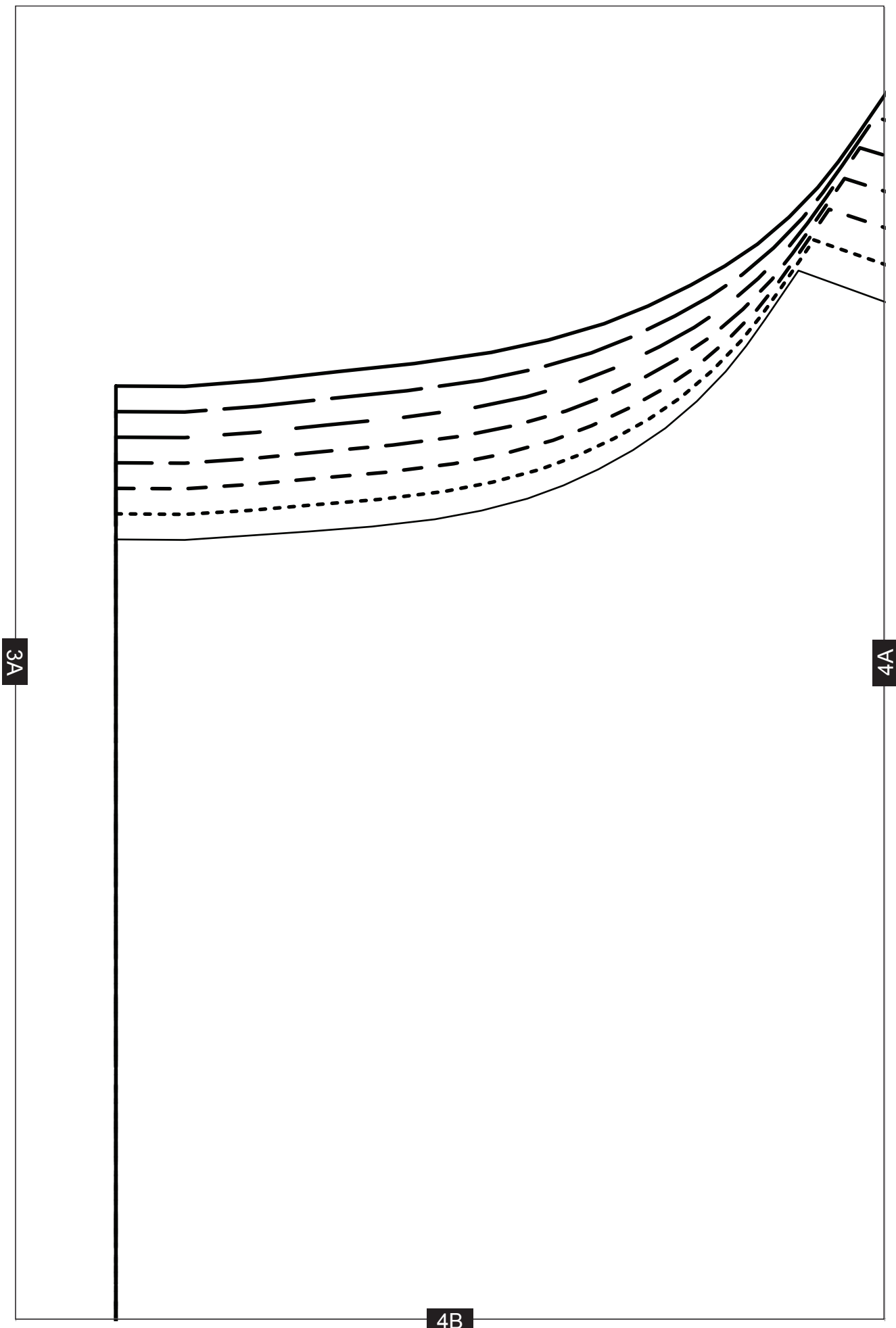

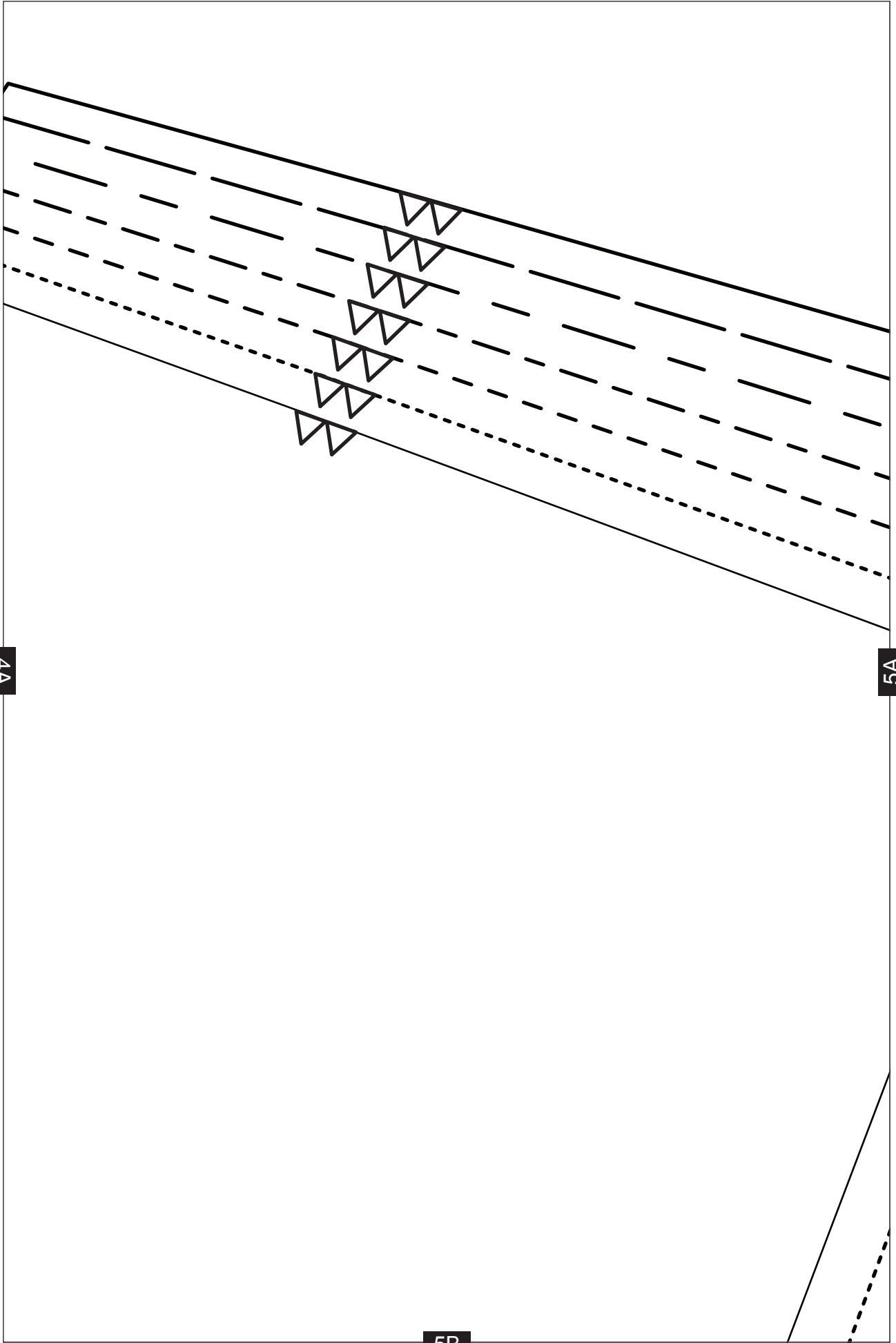

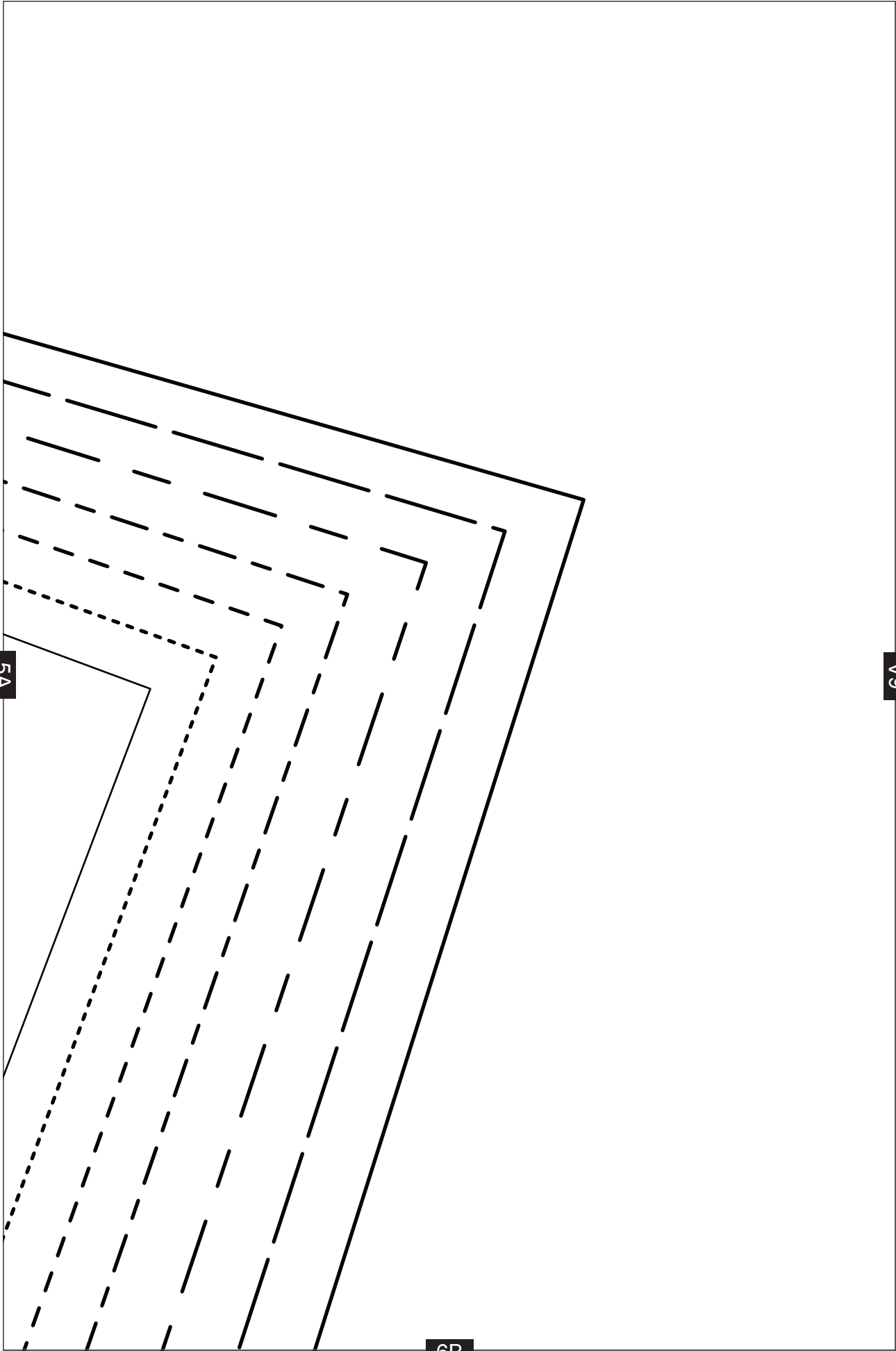

5A

6A

6B

6A

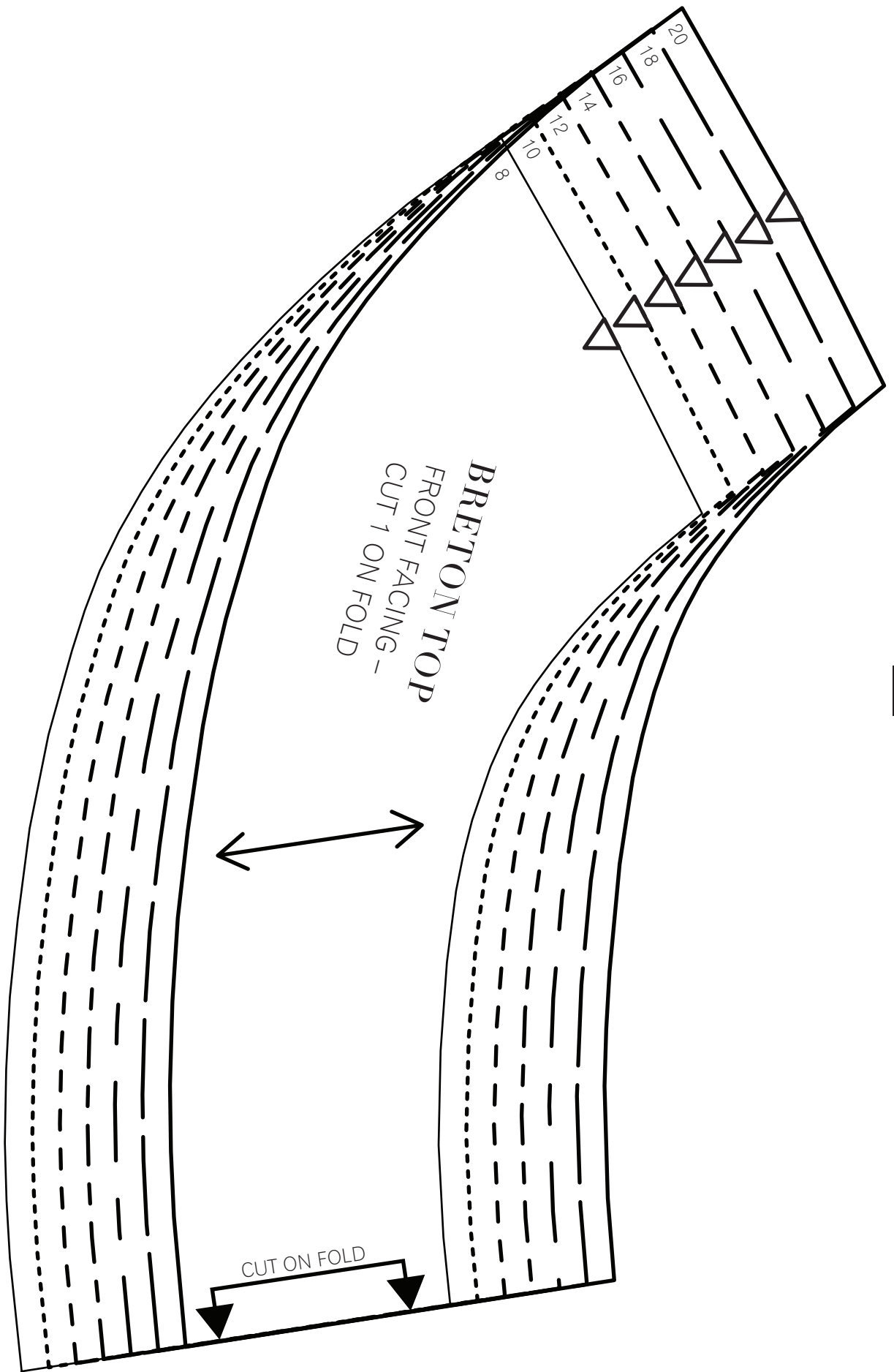

7A

7B

7A

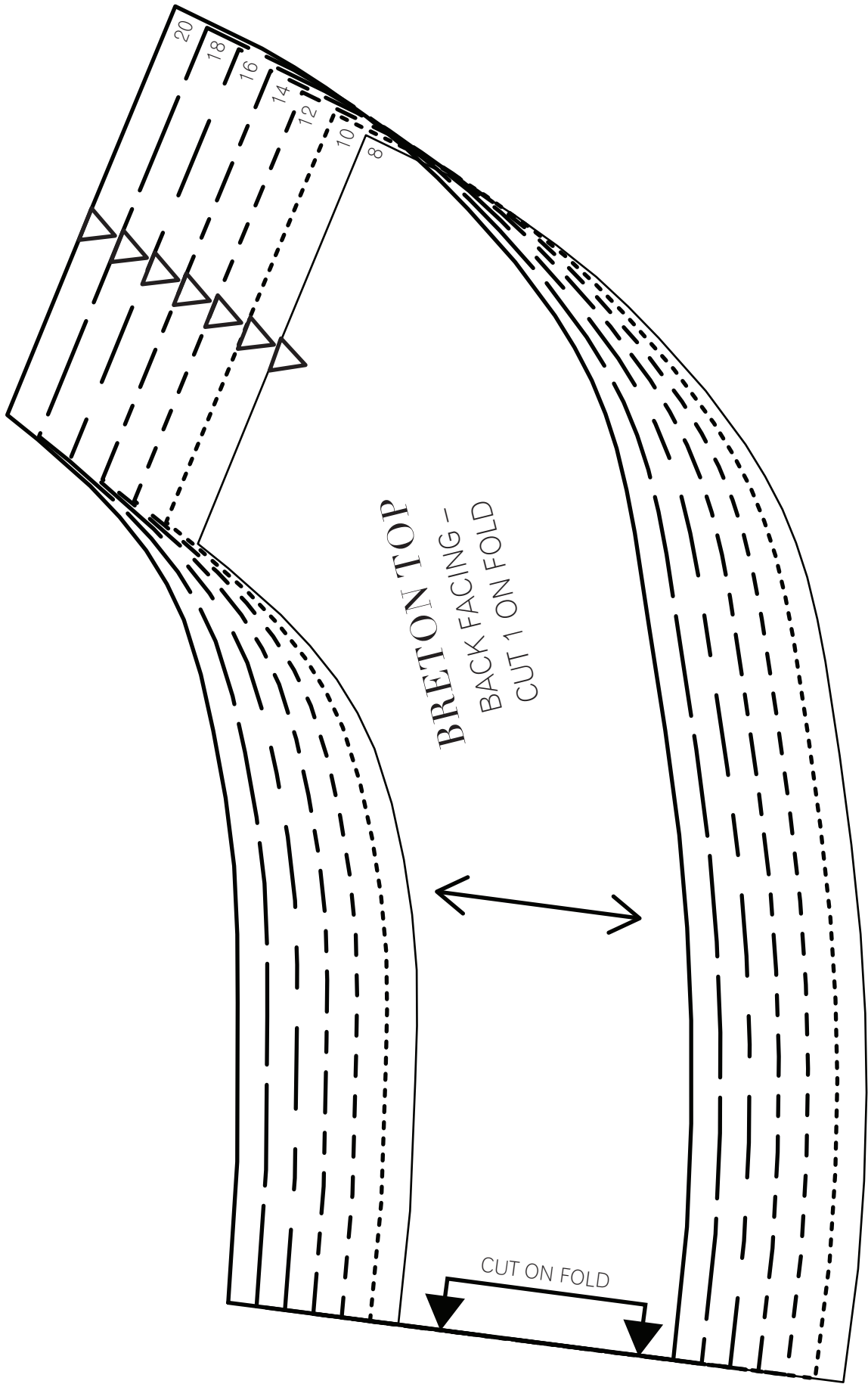

8B

1B

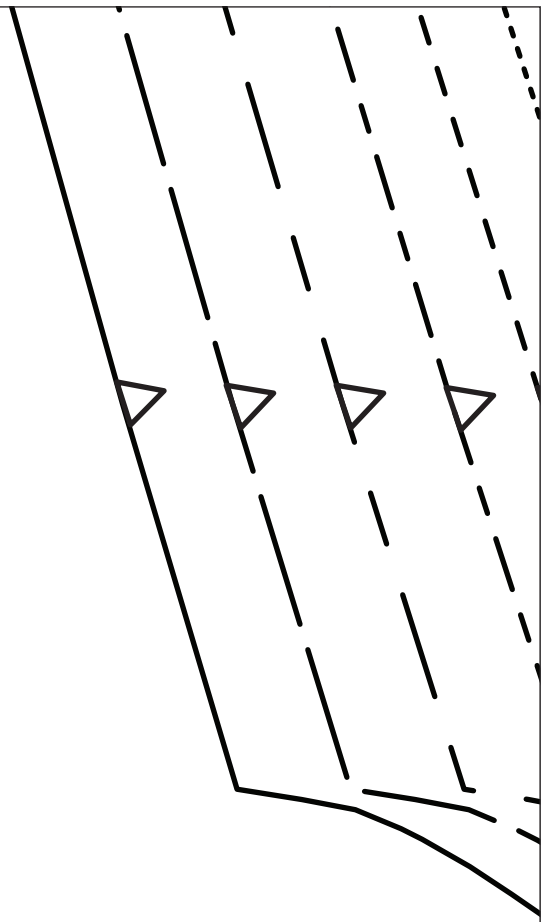

9A

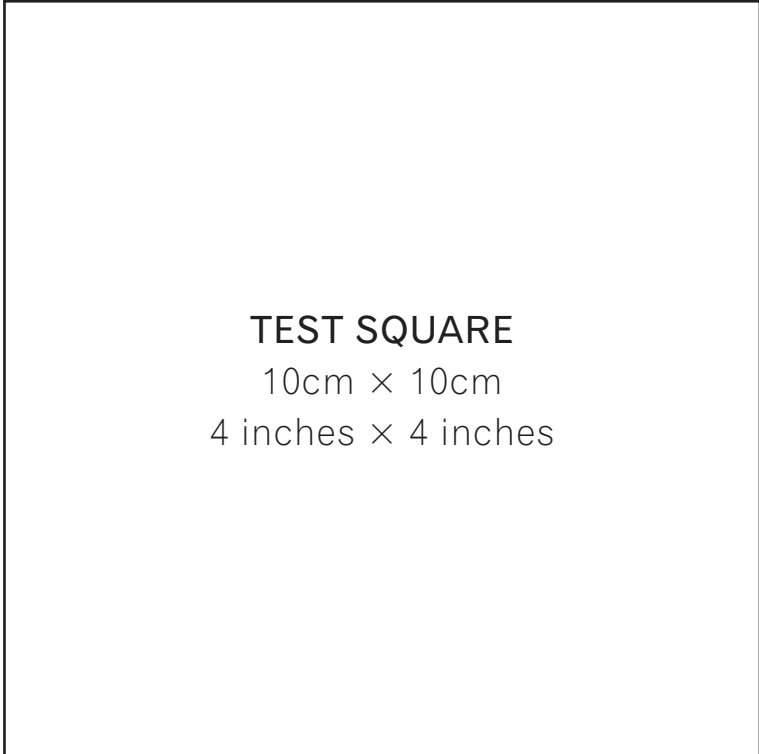

9B

2B



10A

9A

10B

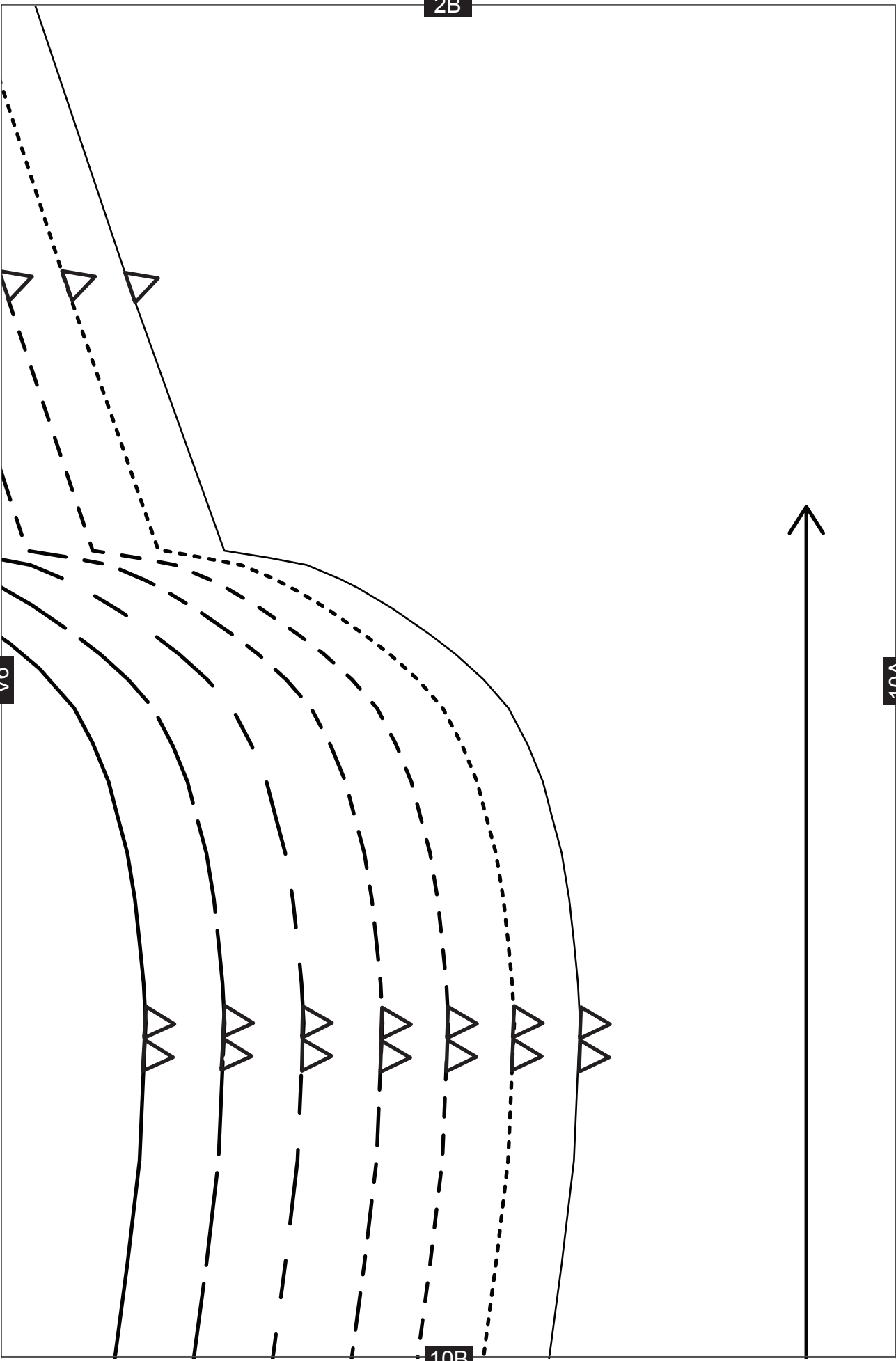

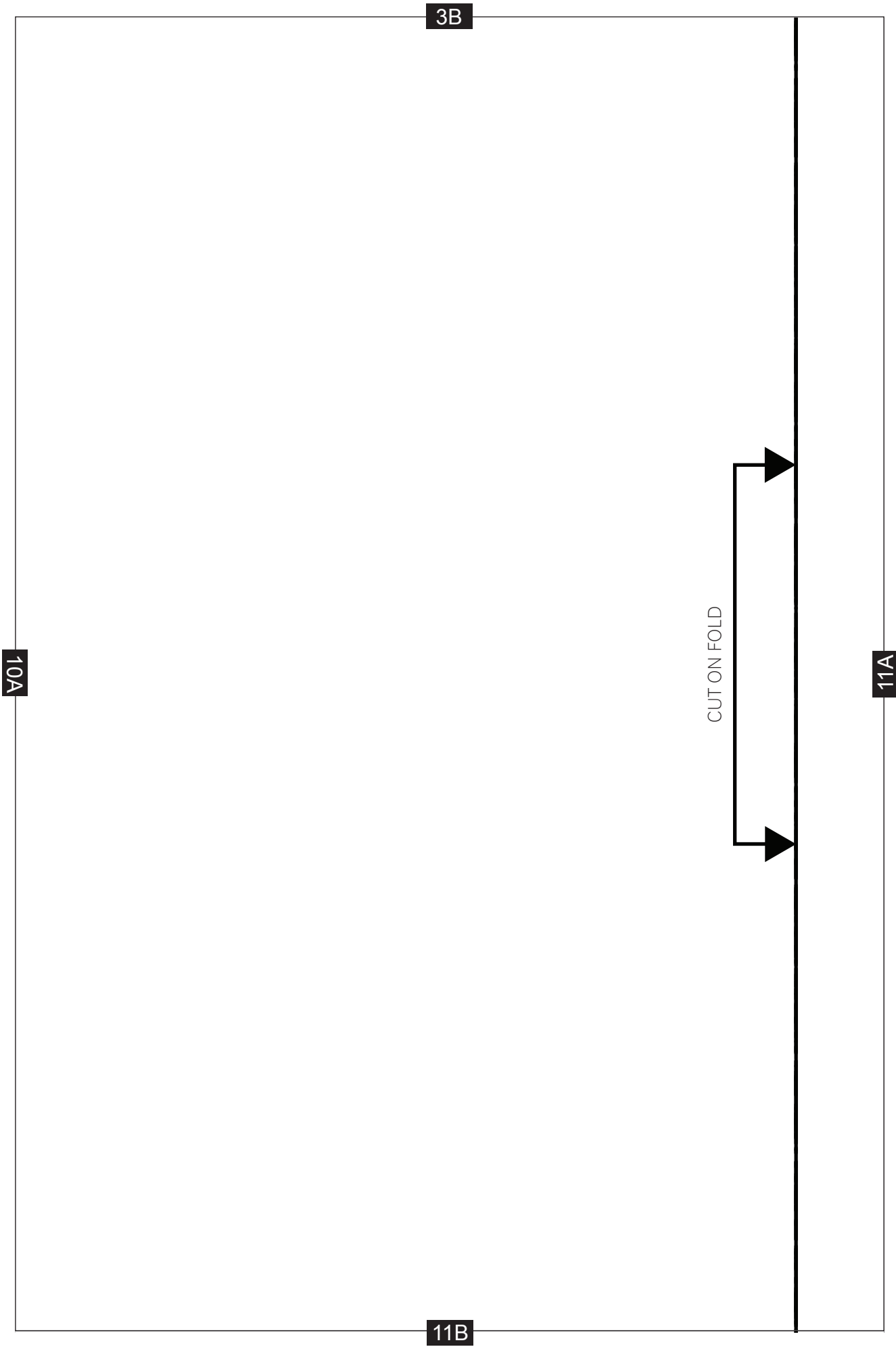

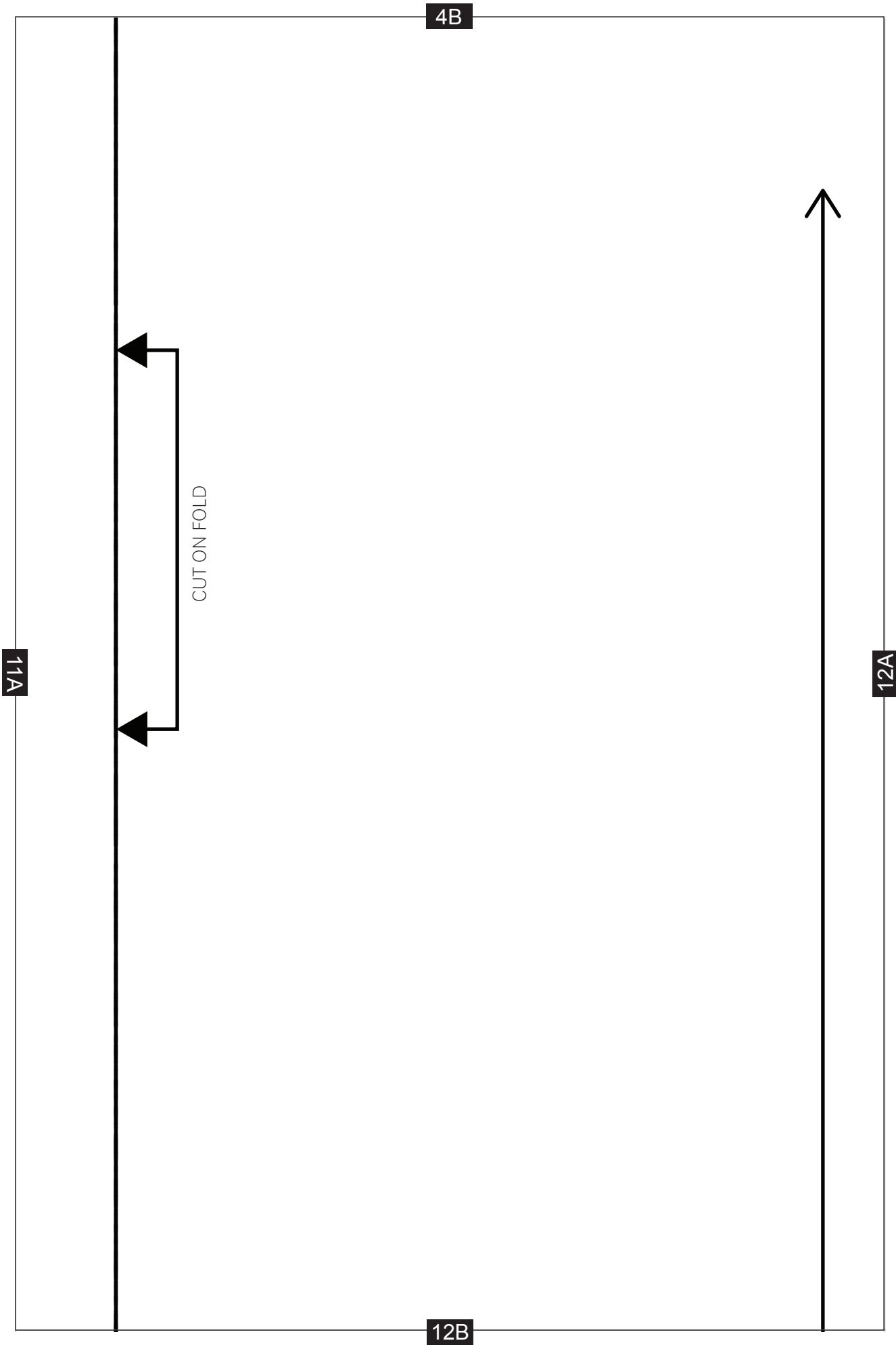

5B

12A

13A

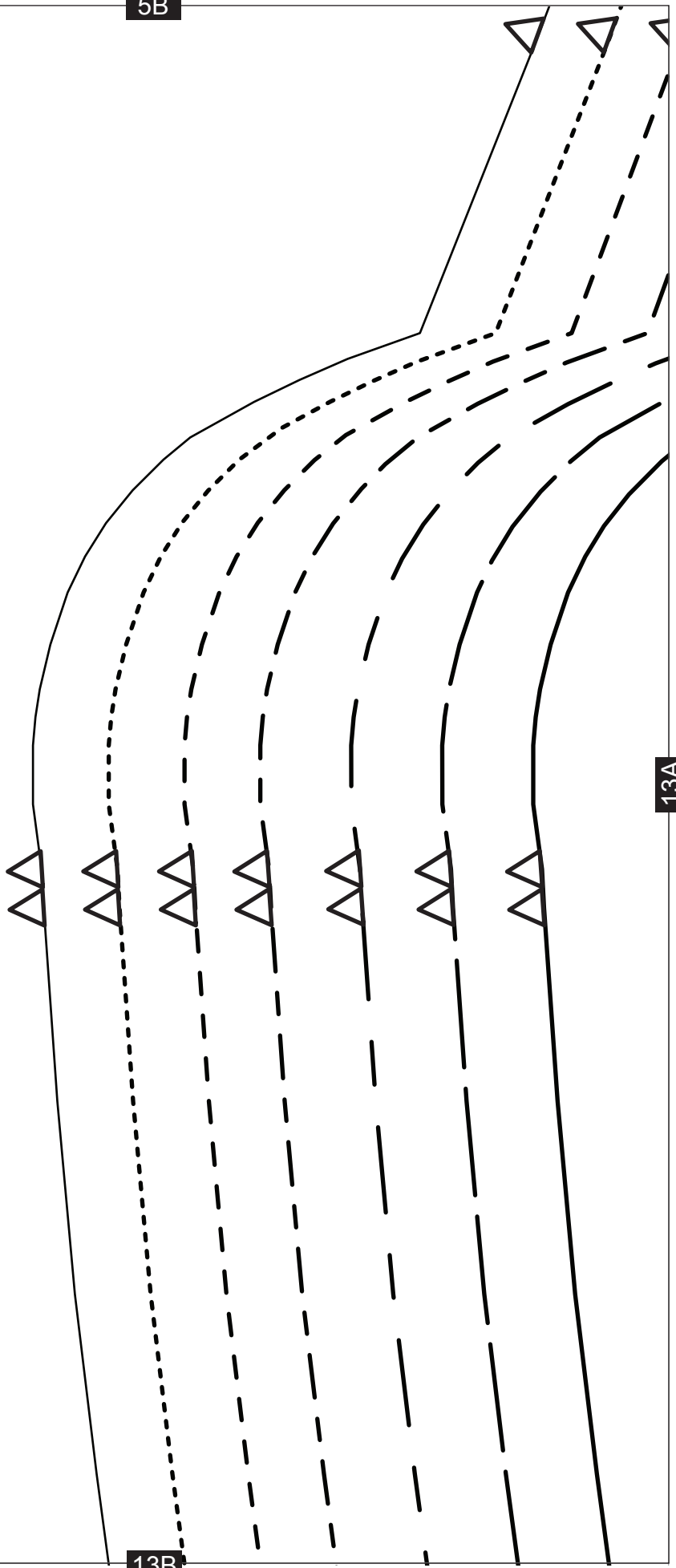

13B

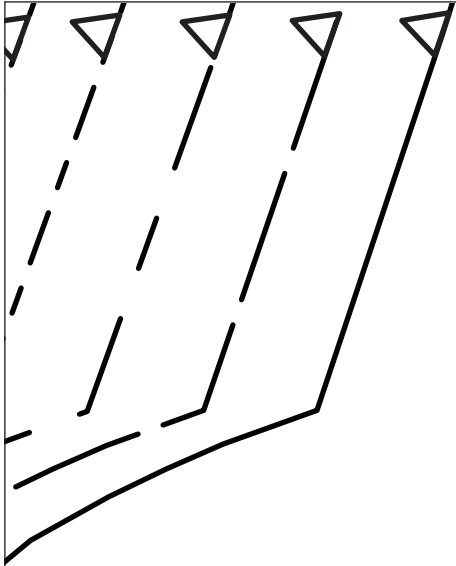

6B

13A

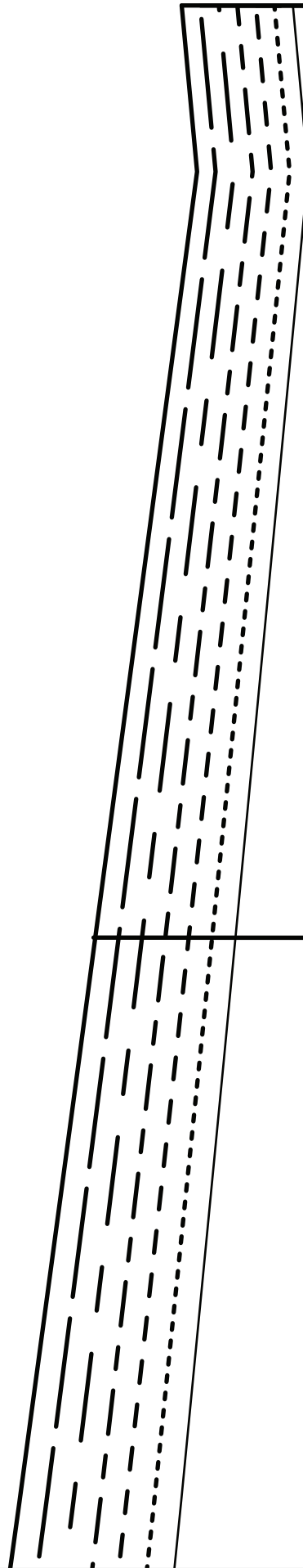

14A

14B

7B

2.5 CM (1 IN.) HEM

FULL-LENGTH SLEEVE

14A

15A



¾ SLEEVE

15B

8B

15A

16B

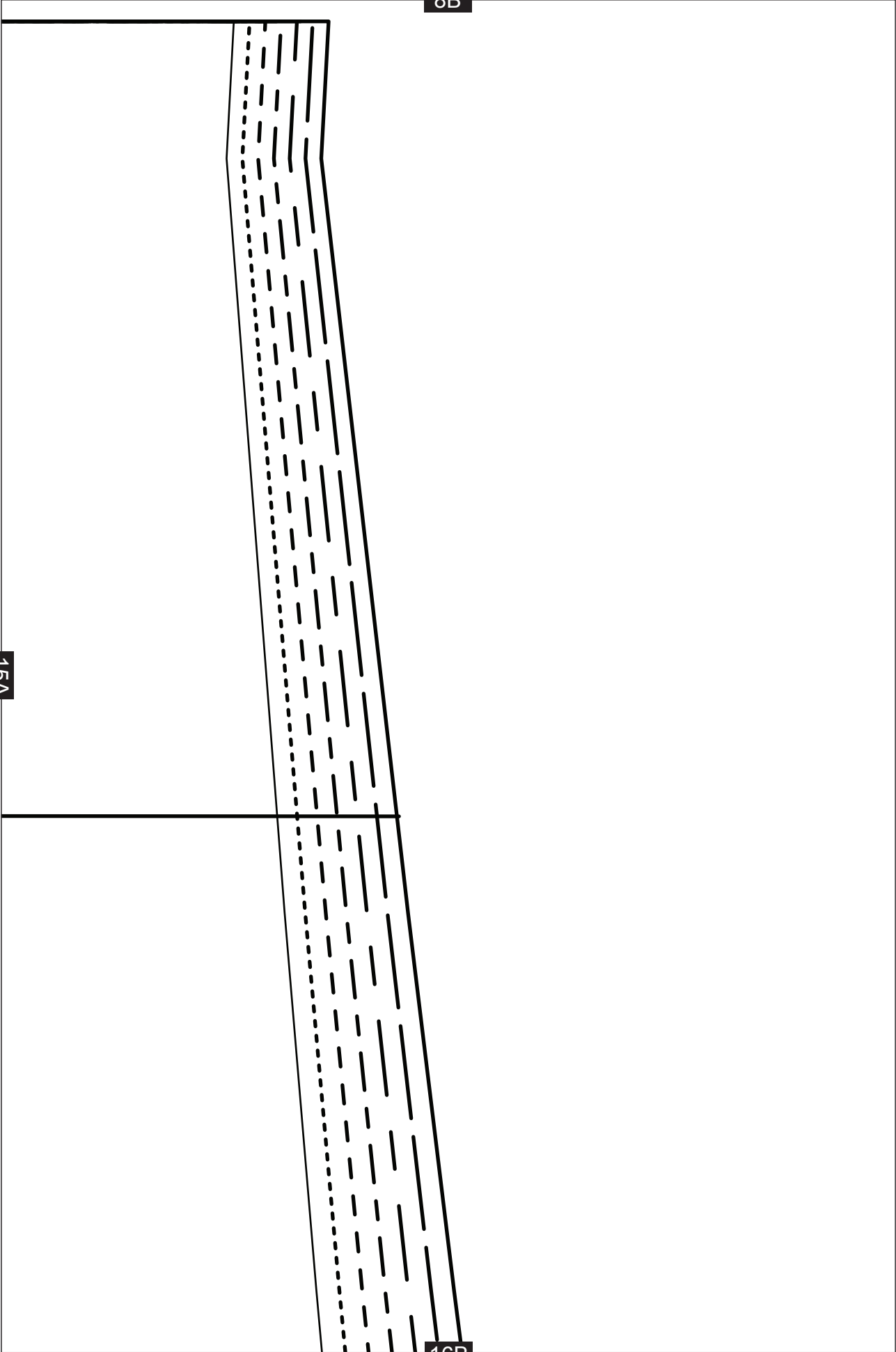

9B

17A

20

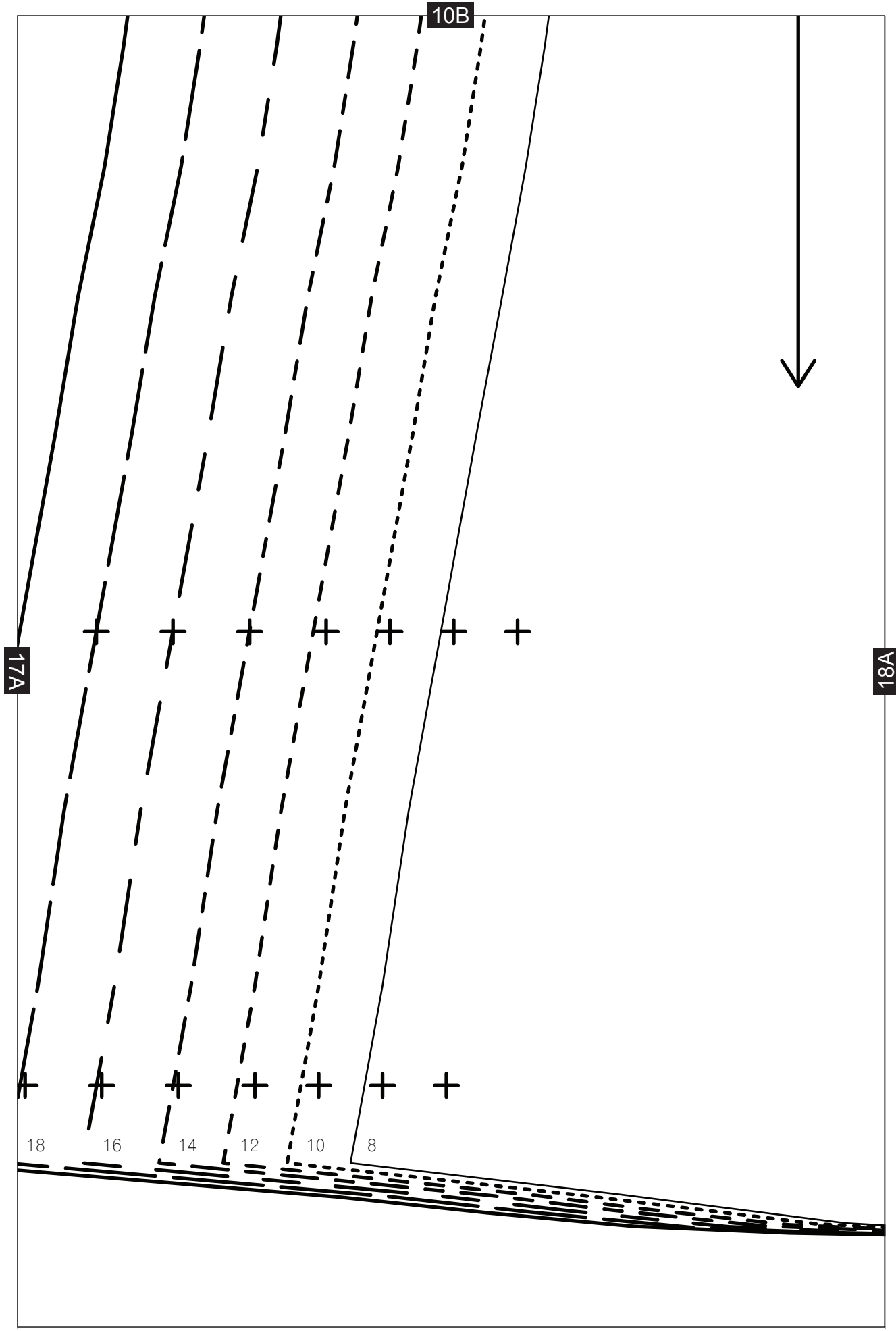

18A

BRETON TOP
FRONT – CUT 1 ON FOLD

11B

19A

19A

12B



BRETON TOP
BACK - CUT 1 ON FOLD

20A

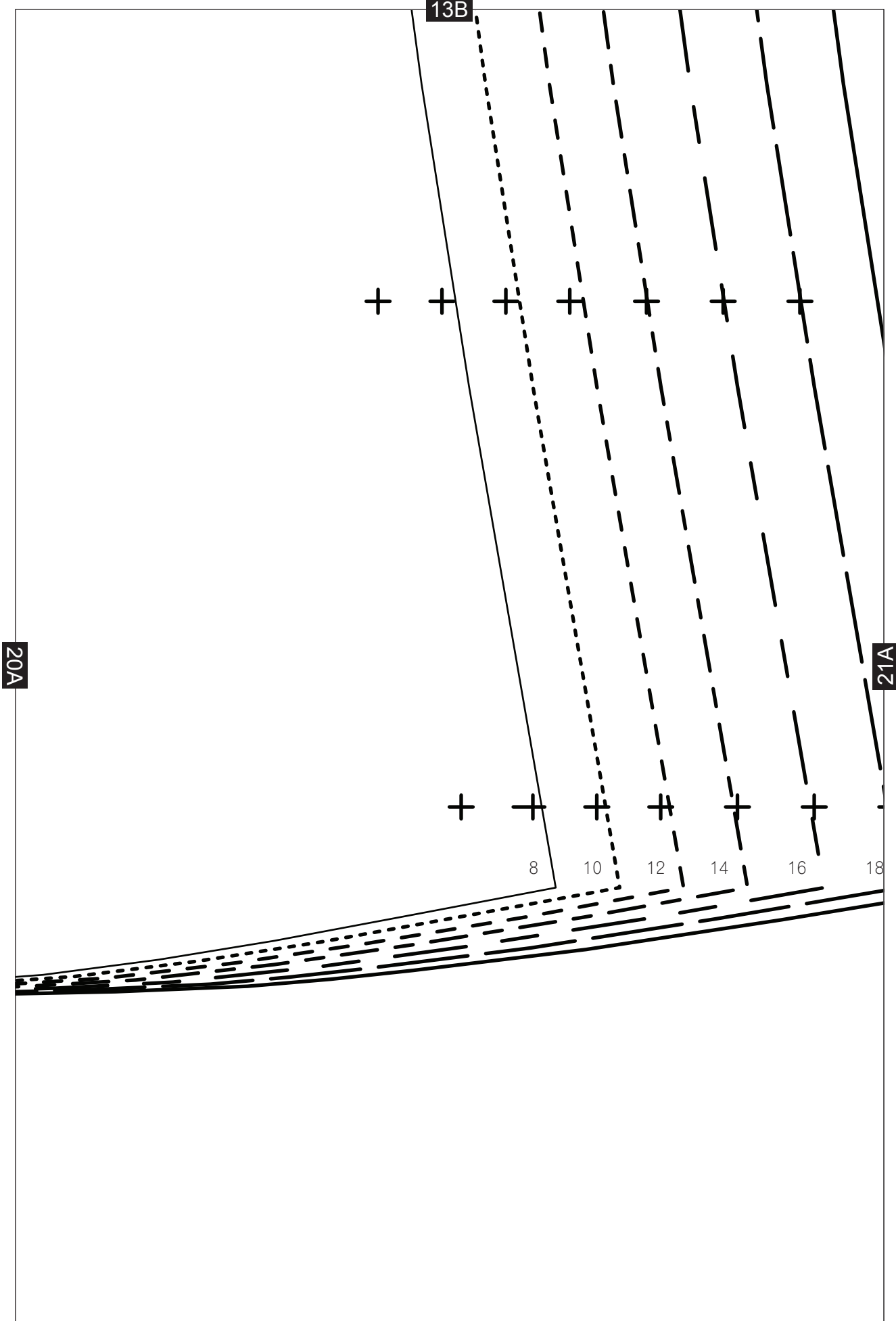

21A

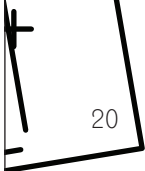

14B

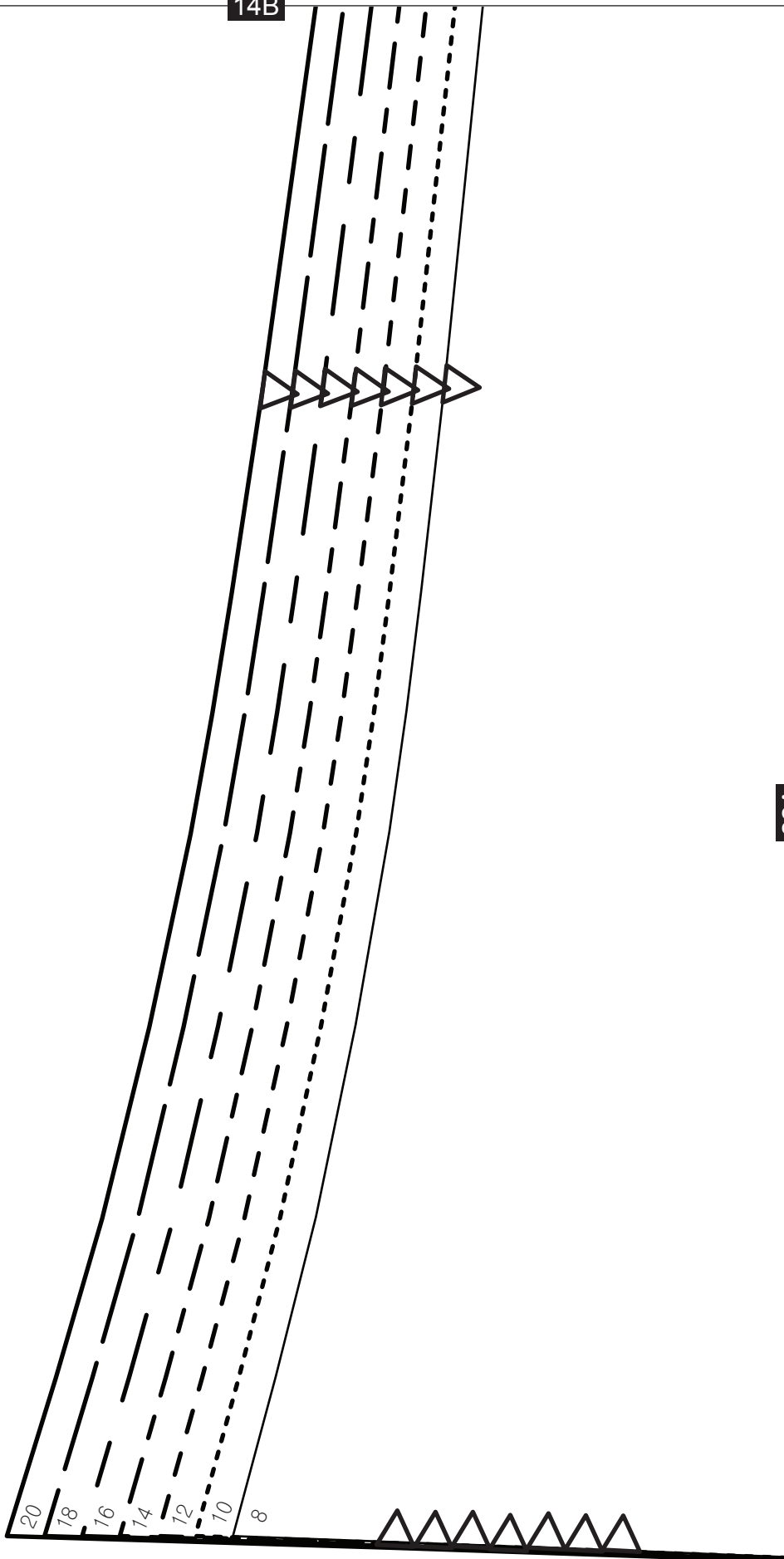

22A

15B



22A

23A

BRETTON TOP
SLEEVE - CUT 2

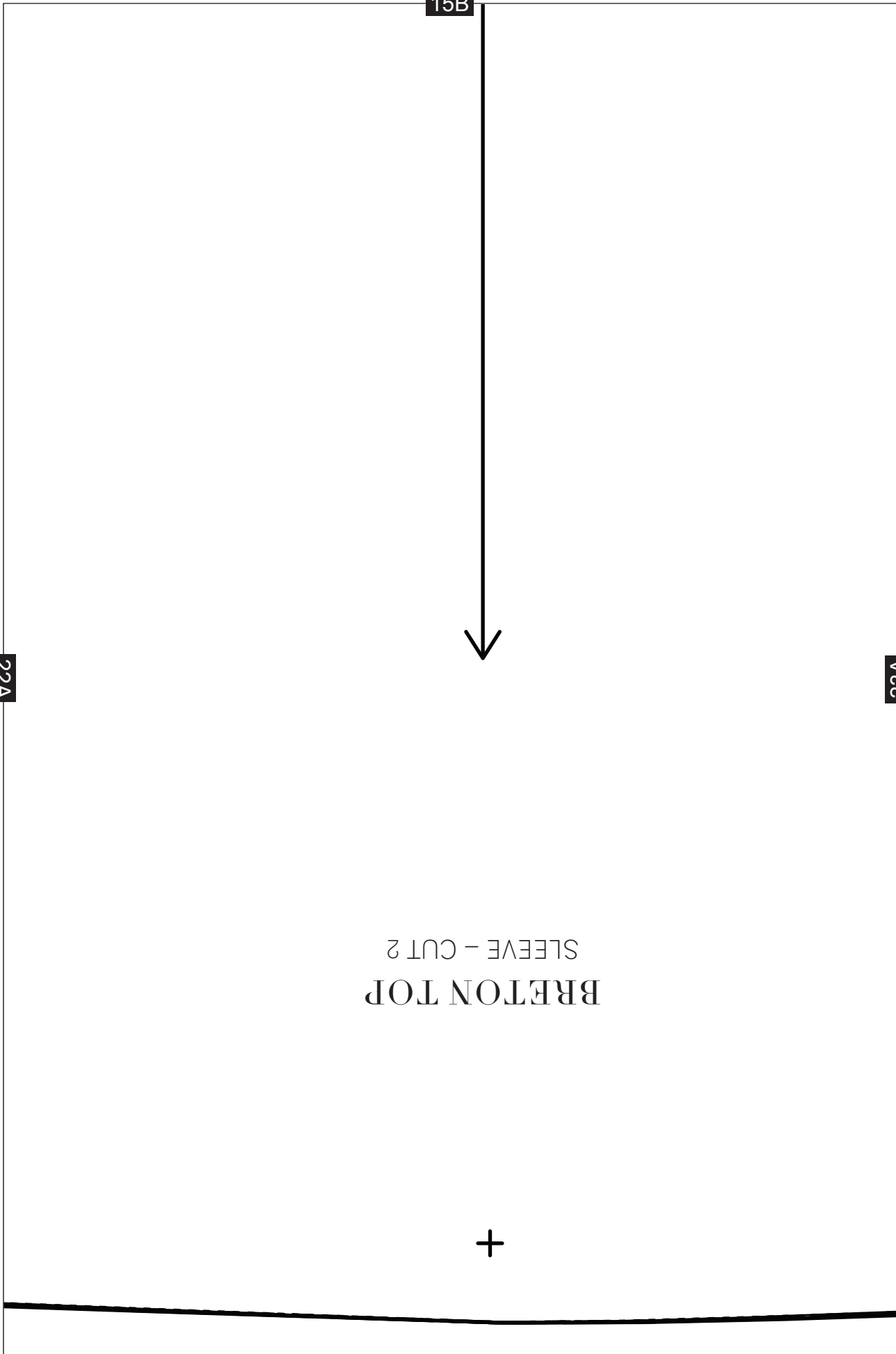

23A

16B

